



Create the Future

NXTR

FUJI Smart Factory Platform



Evolve to create a new future

NXTR offers a truly modular design for the optimal line configuration that caters to your production. Real-time sensing placement, optimized placement actions, and part handling checks after placement are just a few examples. This high end model machine supports new functions that preserve a high level of QCD performance.

NXTR is the next step toward the smart factory of the future.



Modular concept

Exchange heads in a single action

Fuji's original compact lightweight heads can be easily exchanged without using tools. This allows operators to perform maintenance and troubleshoot unexpected problems.



Build module configurations to be optimal for your production

The quantity of robots per module and types of heads used can be selected to match your product, giving you the optimal production equipment.



2R module

1R module

Units for supporting various usages

You can select the optimum supply units to match the production type and parts used. Feeders and other supply devices from other Fuji products you may have can also be used, encouraging efficient use of the units in your assets.

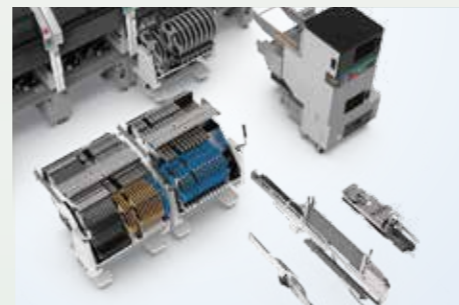

Minimal investment per module

Additional investment can be made on the scale of single modules. You can gradually increase the production capacity to the necessary extent with minimal investment for each.



Simple work paths for efficiency

The modules are designed for single side operation that streamlines and optimizes the operation traffic. This increases efficiency in supplying materials and performing maintenance work.



Automatic, easy, and reliable maintenance offline

Nozzles, feeders, and also heads are applicable for offline maintenance. Using automation units ensures reliable maintenance without requiring any skills. Linking these units with Nexim improves maintenance management.

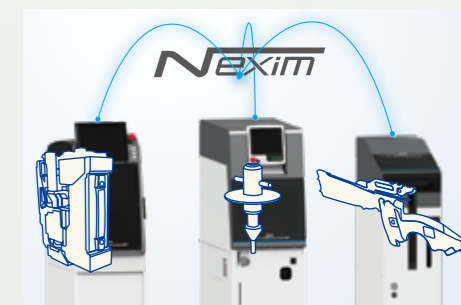

Heads that demonstrate strong capability in production



The three newly-developed heads are capable of handling an expanded part range. They contribute to line balancing and flexible production without drops in production rates even when a different set of parts is used in the next production.

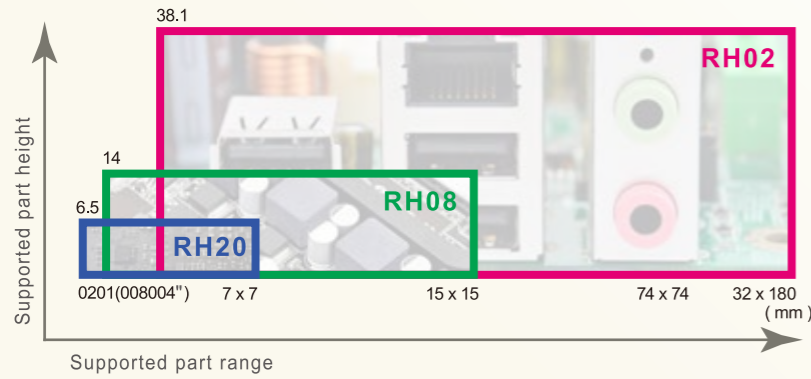

Expanded conveyable panel size

The panel size coverage is expanded so that panels up to 750 x 610 mm are supported "with single conveyors" and up to 370 x 280 mm "with double conveyors" when using dual lane production. From large panel production to highly-efficient production of producing panels in the same size, NXTR line configurations are capable of supporting a greater variety of production.

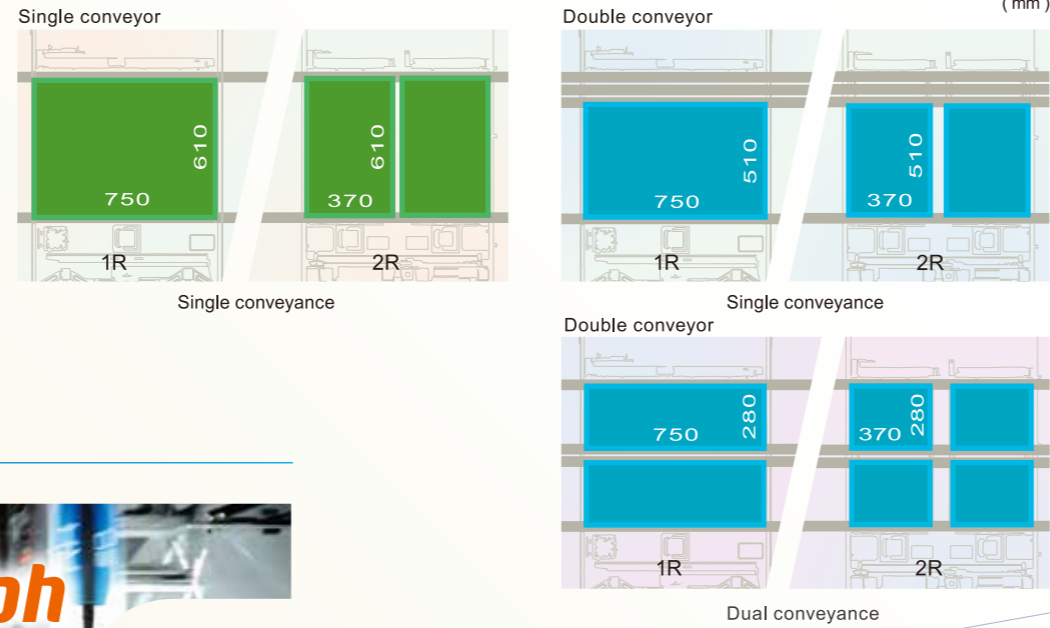

Optimal placement actions tailored to the part

Operation can be optimized in various ways to suit the part being placed, such as by selecting stable and optimal operation speeds and streamlining Z direction strokes in view of the part height. In addition to making it possible to support various parts, this also improves cycle time as well.

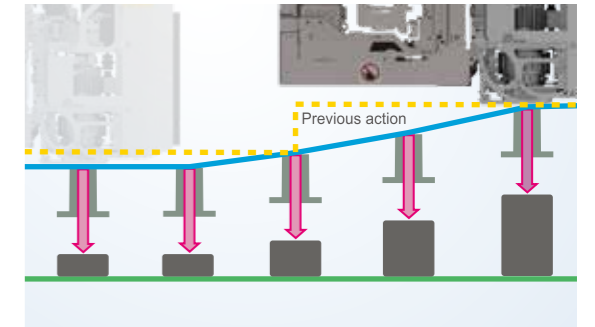

- Multi-level transfer speed
- Shortest Z stroke control

Automatic pin allocation even for soft backup pins*

The appropriate hard-type or soft-type backup pins are allocated automatically. This function comes as a standard option and is an effective measure to reduce work and prevent mistakes during changeover.



- Program-based positioning
- Auto allocation position check

* Under development

World-class speed of placement

Fuji's unique rotary head technology with simultaneous pickup and improved indexing accuracy provides 50,000 cph per robot. This industry-leading placement speed takes productivity to the next level.

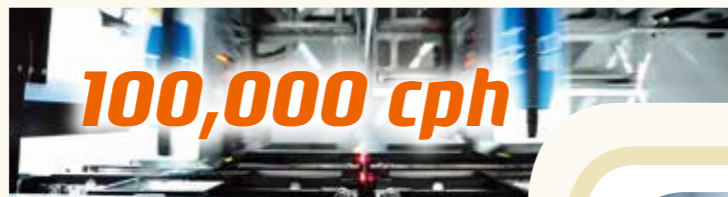

* Cph from a two robot configuration.

Support for various production types

Building production lines with the flexibility to handle various types of production



High quality placement

Maintaining a high level of quality on all placements

Offers high accuracy placement as standard

Placements can be performed with a high accuracy of $\pm 25 \mu\text{m}$ at all times; there are no constraints for the head type or the part to be placed. Additionally, controlling the push-in amount during placement allows for placement with the appropriate pressure.

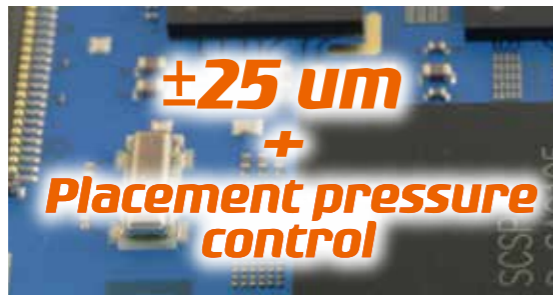

Places parts in a way that they are not affected by changes in the placement surface height

The placement stroke follows changes in the placement height due to panel warpage and distortions, which allows the machine to control the appropriate push-in amount and moreover prevents placement deviations and excess stress on parts and panels.

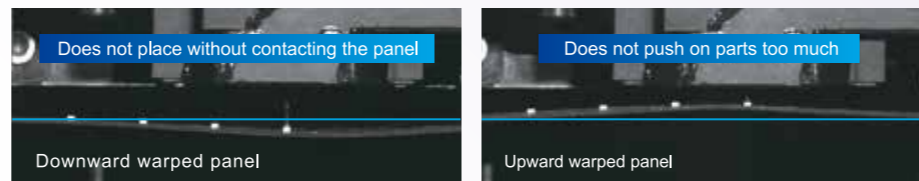

Adjusting the placement height

Checks placement within placement machines

Various checks are available within placement machines to verify the process result shortly after that process: Checking placement immediately following placement, and checking placed parts before placing shield parts, for example. This prevents production of defective products and reduces wasted time and parts.

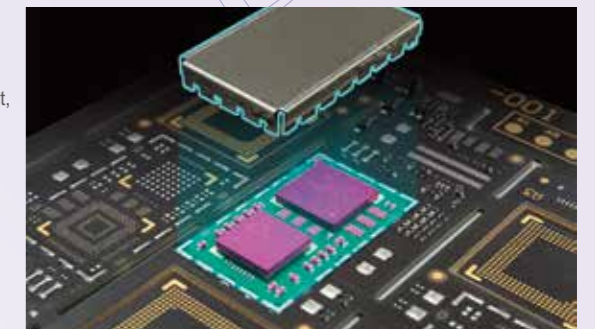

Mark and parts inspection (MPI)

- Part presence check
- Misaligned placement check
- Part direction check

Checks for tombstoned, missing, and upside-down parts

The installed IPS system can cater to a wide range of checks, from part pickup stance to parts remaining on nozzles, as well as upside-down checks for minimold parts. It prevents placement defects attributed to packaging, nozzles, and parts.

- Check for stuck nozzles
- Check for panel contact
- Check for parts presence
- Check for parts remaining on nozzle
- Check for dropped parts



Intelligent parts sensor (IPS)

Prevents defects associated with part properties

Placement defects caused by operation errors and defective parts are prevented by checking the electrical properties of chip parts with LCR checks and by checking the leads and bumps on IC parts with coplanarity checks. (Option)

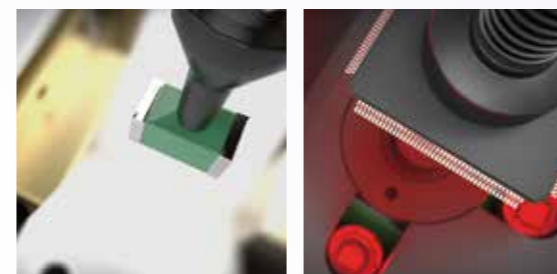

LCR check

3D coplanarity check

Places WL-CSPs with high accuracy

The camera, equipped with advanced lighting technology, ensures vision processing of WL-CSPs and other parts for which the structural context of parts are likely captured in the acquired images. This results in high accuracy placement.

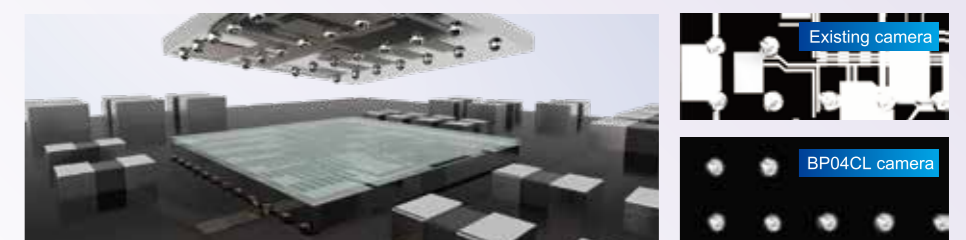

Support for evolving placement processes

Responding to evolving parts and production models, and advancing total line efficiency

Non-stop production

Network conditions are monitored constantly, which prevents production stops associated with network issues from occurring. By automatically saving logs and image data, signs of issues that would cause machine stops and information that would lead to problem solving is not missed, leading to faster recovery times.

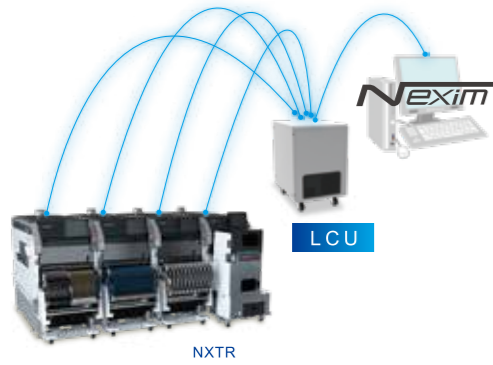

LCU functions

- Collects logs automatically
- Saves all images
- Responds to network issues
- On-machine editing
- Self-diagnosis*
- Multiple language support*
- Remote control*

* Under development

Optimal production line configurations

The most appropriate modules can be selected from the two module types based on the panel size and quantity of feeders to set. It is possible to change modules after the line has been set up.

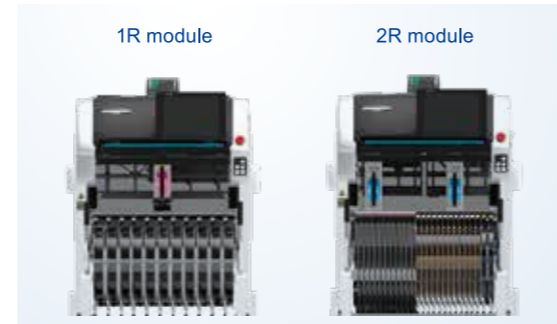

Support for a variety of operation types

A wide variety of supply units are available to support various parts including the smallest parts up to large odd-form parts. The MFU is available with a choice between the bucket type and bucket reel type.

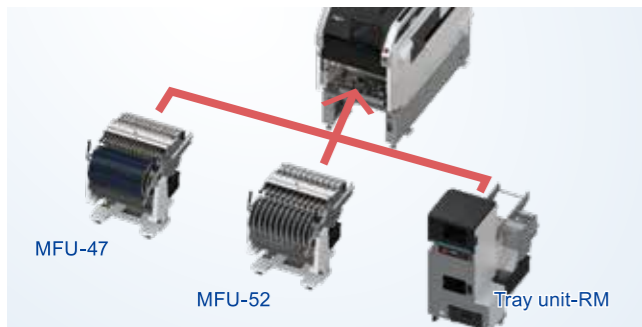

Easy maintenance

Pulling forward the module opens up access to the inside the machine with ease from both sides. This makes it possible to exchange heads and other units and perform maintenance work with a comfortable posture.



High-speed flux transfer

The high-speed type dip flux unit transfers flux onto the bumps of small parts. This leads to high-speed placement. (Option)



Collects waste tape automatically

Waste tape is collected automatically into one place to reduce operator work that previously needed to be performed regularly for each module. (Option)

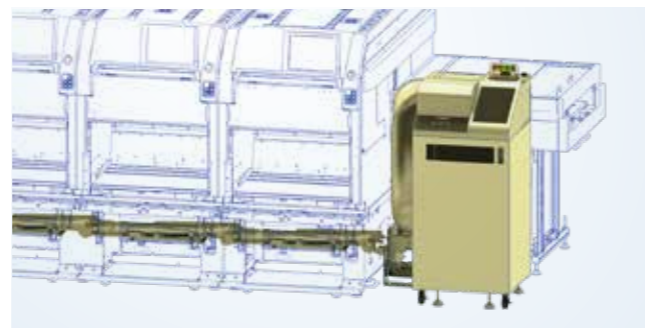

Manufacturing sites are all unique, and they have different ways of production that involve a variety of issues.

Fuji Smart Factory aims to solve these issues, which in turn improves factory productivity and flexibility as well as maximizes the QCD performance of manufacturing.

FSF

FUJI Smart Factory



System overview

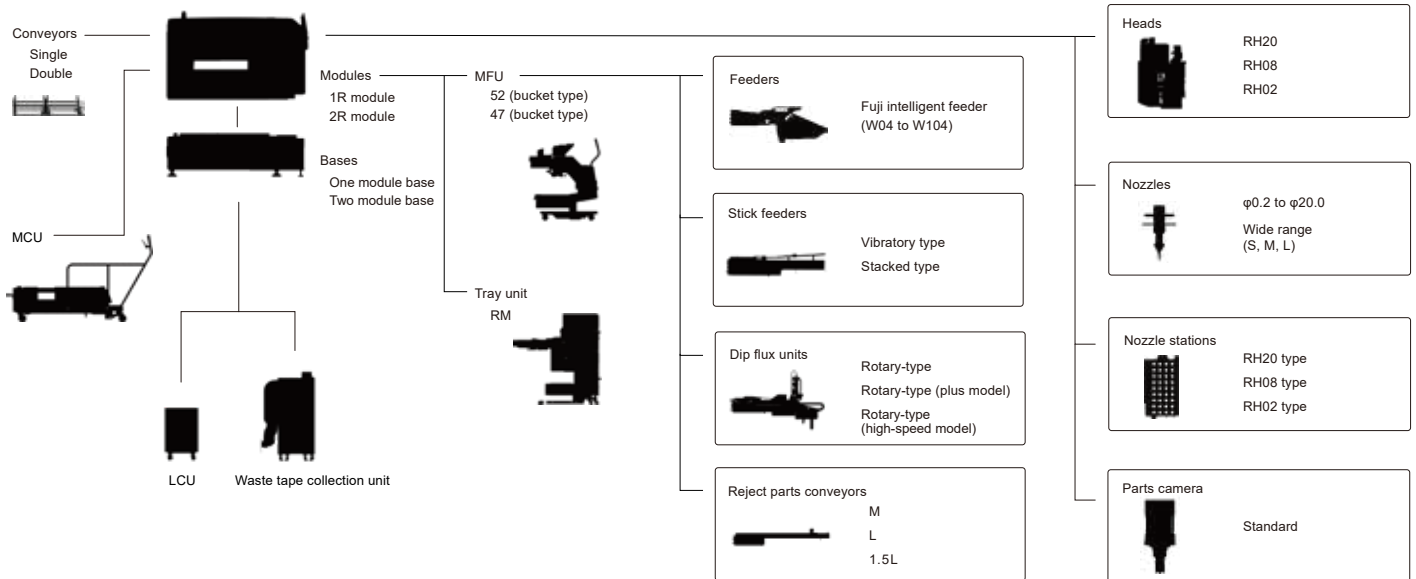

External dimensions

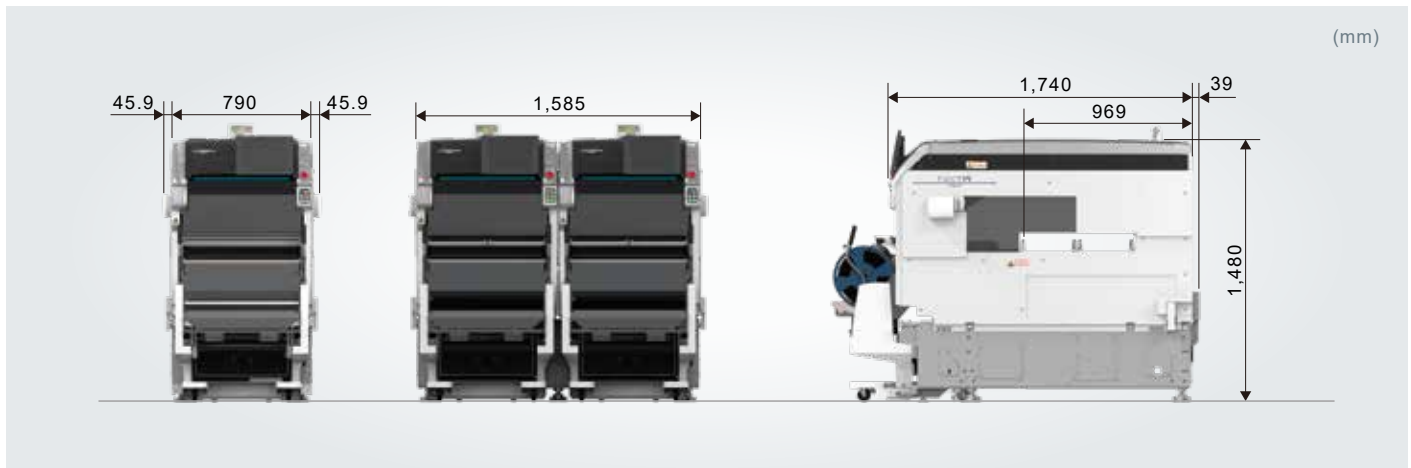

Specifications NXTR (S model)

Module		1R module		2R module	
Panel size (L x W)	Single conveyor	48 x 48 to 750 x 610 mm		48 x 48 to 370 x 610 mm	
	Double conveyor	Single conveyance	48 x 48 to 750 x 510 mm		48 x 48 to 370 x 510 mm
Dual conveyance		48 x 48 to 750 x 280 mm		48 x 48 to 370 x 280 mm	
Weight		610 kg		730 kg	
Base		One module base		Two module base	
Air consumption		50 L/min (ANR)		100 L/min (ANR)	
Weight		430 kg		800 kg	
Head		RH20	RH08	RH02	
Throughput *1		46,000 cph	24,000 cph	8,000 cph	
	Productivity priority mode	50,000 cph	-	-	
Placing accuracy *1		±0.025 mm Cpk ≥ 1.00			
Power		3-phase AC 200 to 230 V ±10 V (50/60 Hz)			
Air		0.4 MPa			

*1 Under optimum Fuji conditions.

FUJI CORPORATION

19 Chausuyama, Yamamachi, Chiryu, Aichi 472-8686 Japan

Tel: +81 566 81 2110
Fax: +81 566 83 1140

- The contents of this catalog are subject to change without notice due to constant product development.
- The information in this catalog is current as of May 2020.

© 2020 FUJI CORPORATION. All Rights Reserved.